

WALL / WINDOW AXIAL FANS















- New design to complement with modern decor.
- To exhaust air directly to the outside or into a short length ducting (max 3 m length).
- Suitable for toilets, bathrooms, WC's, shower-rooms, utility rooms and kitchens.
- For wall, panel, ceiling and window installation (window kit upon request).
- Available sizes: Ø 100, Ø 120, Ø 150.
- Manufactured in shock-proof high quality technopolymer.
- Available with fixed grille (GF models) or with internal gravity shutters (GG models).
- Maintenance free, self lubricating sleeve bearing motor for long life and noiseless running.
- Impedance protected induction motor, 230V – 50 Hz.
- Easy maintenance and cleaning.
- Designed to ensure energy saving.
- Fans comply with EN 60335-2-80, EC Low Voltage Directive 73/23 - 93/68 and EC Directive EMC 89/336.

Options:

- Timer (adjustable from 3 to 25 minutes)
- Humidity control (40 – 80 R.H.)
- Pull cord
- Ball bearing motor
- SELV version (12 V.a.c.)
- Double speed version for Silent Running

SPECIFICATION

model	m ³ /h	Pa	W	dB (A) @ 3 m	protection	marked	type
ECO 100 GF	90	27	11	39	IPX4	CE  	EC 10
ECO 120 GF	170	40	15	42	IPX4	CE  	EC 12
ECO 150 GF	320	70	26	49	IPX4	CE  	EC 15
ECO 100 GG	80	27	11	39	IPX4	CE  	EC 10
ECO 120 GG	155	40	15	42	IPX4	CE  	EC 12
ECO 150 GG	290	70	26	49	IPX4	CE  	EC 15

DIMENSIONS (mm)

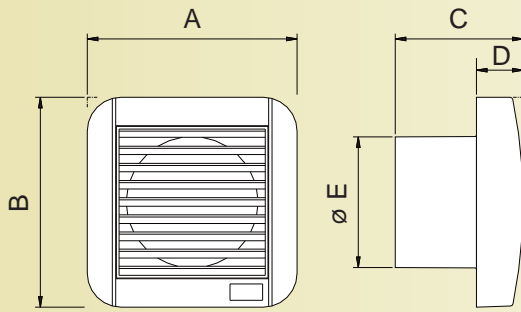

model	A	B	C	D	ø E	Kg.
ECO 100	155	155	92	35	97	0,5
ECO 120	180	180	121	51	119	0,8
ECO 150	209	209	137	52	149	1,2

CURVES

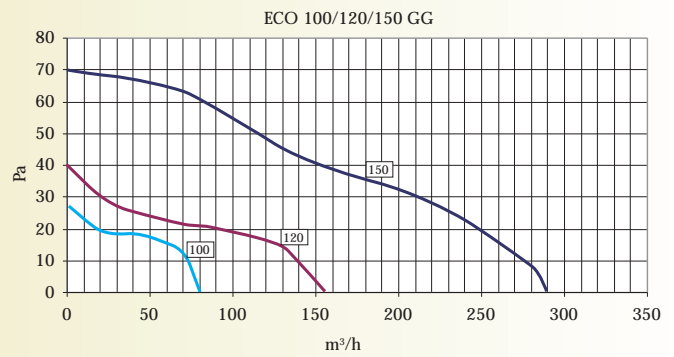
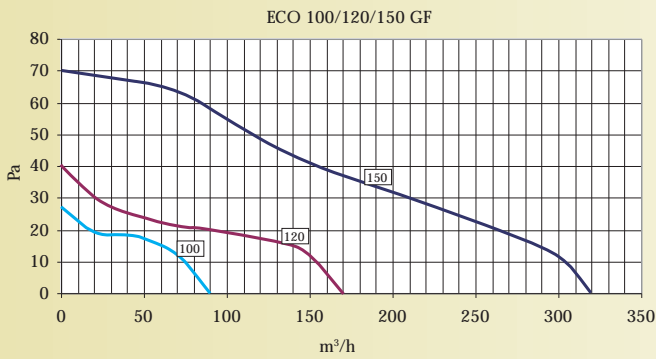

APPLICATIONS

WALL

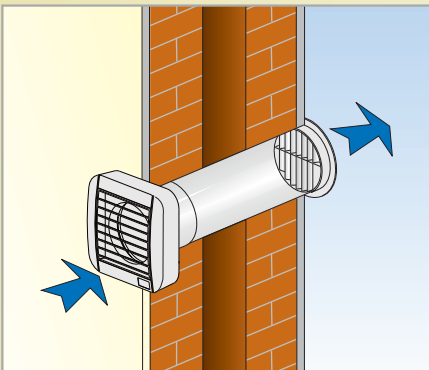

CEILING

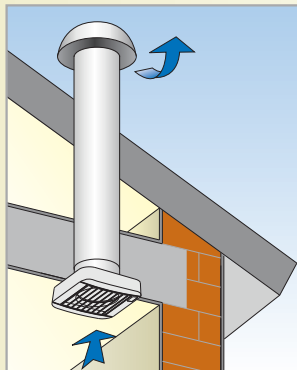

WINDOW

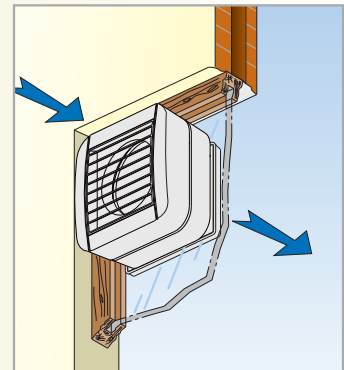

Wiring can be surfaced or recessed.